



Improved Routing Protocol for Extending Wireless Sensor Networks Lifetime

Banumathi ¹, Muthumari ², Shahada Syed ³, Syed Basha Shaik ^{4,*}

^{1,4} Department of Information Technology, University College of Engineering Nagercoil, India.

² Department of Computer Science and Engineering, University College of Engineering, India.

³QIS Engineering College, India

Email: jbanu85@yahoo.co.in; muthu_ru@yahoo.com; shahada.sd@qiscet.edu.in;
basha.sd@qiscet.edu.in

Corresponding Author Mail: basha.sd@qiscet.edu.in

Abstract

One of the most cutting-edge technological trends to emerge over the past ten years is the availability of ubiquitous networks and the rising demand for them. The objective remains to have access to several services, including voicemail, the web, emails, messages, and other ones, without being restricted by one's geographical location. As a result, there will be an increase in the need for wireless networks for communication. The wireless network industry has had remarkable growth over the last several decades, and they make new advancements in this field. An ad hoc network is a non-stationary infrastructure that allows for the establishment of a sort of wireless network in which one node may share information with several other nodes through multi-hop links and interconnections. This type of network is also known as a mesh network. An ad hoc system is one that does not have a centralized control unit and instead relies on a collection of wireless mobile nodes to construct a functional wireless network. Newline Instead of using stationary network communication, this kind of network uses a multi-hop point-to-point routing technique to create a network connection. Because mobile nodes have a limited range, a problem may occur when one node has to connect with another node that is located outside of its range but is still inside its coverage area. In such cases, a connection between the origin and the destination should be made by linking several nodes. The criteria used to determine which nodes should participate in the routing process depend on a variety of different factors. In spite of this, the primary objective is to construct a route from one end to the other in order to provide the nodes with a transmission medium so that they may connect with one another. The process of routing data in ad hoc networks has become very difficult ever since the debut of wireless networks. The inherent characteristics of an ad hoc network, in which the topologies of the network are always subject to change, are the primary cause of this kind of challenge. Because ad hoc networks are inherently dynamic, there will be various performance concerns with the routing and transmission of data. The proposed work provides to become aware of the various performance issues that may arise from the use of routing protocols in mobile ad hoc networks. To evaluate the routing protocols in terms of their effectiveness in the context of wireless mobile networks and wireless static networks. For the purpose of assessing the performance of this network scenario, both mobile and static nodes are utilized.

Keywords: Adhoc; wireless network; transmission medium; dynamic; Routing protocols; mobile and static nodes.

1. Introduction

The availability of ubiquitous networks and the growing demand for them are two of the most cutting-edge innovation trends that have emerged over the course of the last decade. The goal is still to get access to a variety of services, such as e-mails, texts, voice mail, the web, and so on, without being constrained by physical location. As a result, the need for communication through wireless networks is only going to continue to rise. Over the course of the last several decades, the business of wireless networks has seen tremendous growth, and ongoing improvements in this area are being produced all the time. An ad hoc network is a non-stationary infrastructure that allows for the establishment of a sort of wireless network in which one node may share information with several other nodes through multi-hop links and interconnections. This type of network is also known as a mesh network. An ad hoc system [1] is one that lacks a centralized control unit but is instead made up of mobile wireless nodes. These nodes collaborate to create a functional wireless network. In place of stationary network communication, this category of networks makes use of a multi-hop point-to-point routing technique to set up network connections [2].

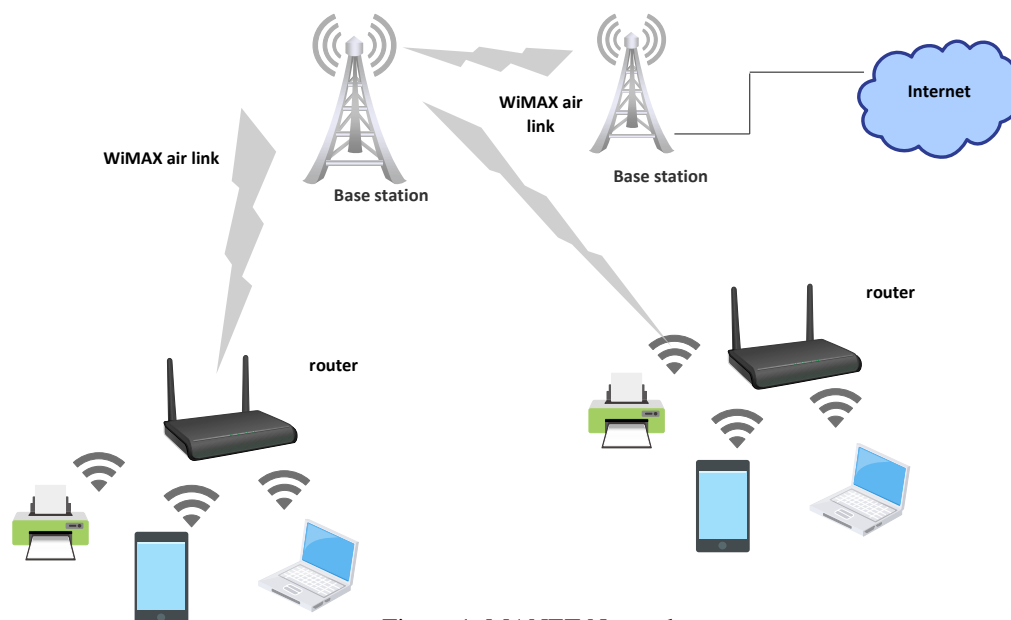

Figure 1: MANET Network

Because mobile nodes have a limited range, a problem may occur when one node has to connect with another node that is located outside of its range but is still inside its coverage area. In circumstances like these, a link between the origin and the destination should be established by the joining of many nodes. The criteria for deciding which nodes should take part in the routing process are contingent on a number of different elements. In spite of this, the most important objective is to construct a route from one end to the other in order to provide the nodes with a transmission medium so that they may connect with one another. The process of routing data in ad hoc networks has become very difficult ever since the debut of wireless networks. The inherent characteristics of an ad hoc network, in which the topologies of the network are continually changing [3] are the primary factor contributing to the difficulties of the situation. Because ad hoc networks are inherently dynamic, there will be a number of performance concerns with regard to the routing and transmission of data. The process of discovering the most efficient and effective routes by which data may be sent from one node to another within a network is known as routing.

Once the path has been decided upon, the transmission of data packets is a straightforward process that takes place here. On the other hand, determining the best way to go there is a phenomenon that may be rather difficult [4]. As a result, the transfer of data between various nodes necessitates the use of distinct routing methods. The success of network communications, as well as their dependability and efficiency, are directly proportional to the efficacy of the routing protocols that are used. The

purpose of the efficient protocol is to improve the performance of the network by determining the most effective path to take in any given scenario [5]. The performance evaluation of routing protocols can be determined by taking into account a large number of factors that have the potential to dictate the efficiency of the protocols. These factors include but are not limited to, delays in connectivity, loading, traffic, QoS (quality of service), and other factors. However, in the past, a number of studies [6-8] have been conducted in order to determine the factors that are involved in the performance evaluation of routing protocols in ad hoc networks [9].

Despite this, the results that were achieved were still not adequate, and furthermore, there is a need for additional data pertaining [10-12] to the comparative study of different protocols. The purpose of this proposed work is to determine various performance issues that are encountered by a routing protocol and then analyze the selected routing protocol in relation to selected performance parameters for three different network conditions [12-15]. Ultimately, the goal is to come up with a solution to these performance issues.

1.1 MOBILE AD HOC NETWORK

Mobile ad hoc networks are groups of wireless devices, also known as nodes, that are able to interact with one another and transmit data in a fluid manner. These networks are referred to as mobile ad hoc networks. Personal computers, such as desktops and laptops, that have a wireless connection, personal digital assistants (PDA), mobile phones, tablets, and other electronic devices are all instances of wireless nodes. A wireless node is a comprehensive phrase. MANET [15-17] is an abbreviation that stands for mobile ad hoc network. It is a wireless network that is regarded to be infrastructure-less, infrastructure-configuring, and self-administrating. The MANET is dynamic, and its nodes are free to move across the network in whatever direction they want.

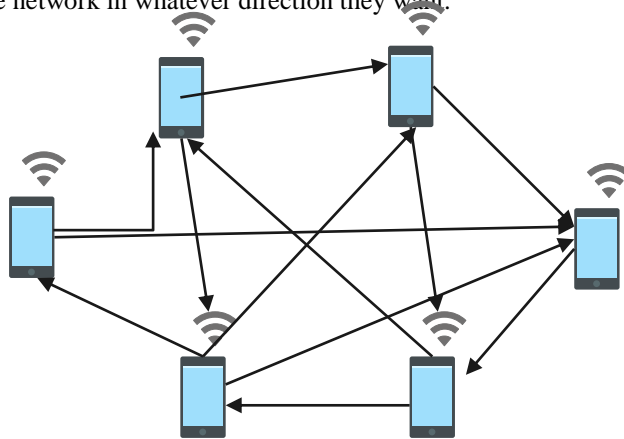

Figure 2: Concept of MANET

A node is generally understood to refer to any digital equipment that is capable of sending or receiving data via the atmosphere, which is just air. These kinds of devices may be carried by a person, installed in a huge aircraft or vehicle, or implanted in any other kind of portable devices, such as a mobile phone, a tablet computer, or anything else. Every node that makes up a MANET must sometimes operate as a router in order to pass the data traffic that may not be of any benefit to that particular node. Because the locations of the nodes might change at any time, the most difficult part of building an effective MANET is the responsibility of providing the nodes with the information relevant to the routing. As a result, a MANET is able to run the network all by itself, without the need for a centralized administrating device or base station.

The objective of this proposed work is to conduct research comparing the effectiveness of a number of different wireless routing protocols within the context of a mobile ad-hoc network and to identify the factors that contribute to variations in the effectiveness of those protocols. Based on the factors that are affecting the performance, some modifications are proposed that, when implemented, would effectively raise the channel usage.

The consumption of energy and its application to reduce the likelihood of collisions in the channels are mapped out. The performance may be improved with the assistance of this data by lowering the collision rate and raising the channel usage rate respectively. The following is a condensed version of the goals: 1. To conduct an exhaustive review of the relevant literature in order to conduct an in-depth analysis of the current trend of wireless routing protocols being used in Adhoc networks. 2. To examine different hierarchies and configurations of routing protocols in a total of sixteen mobile ad hoc networks 3. To be aware of the many performance challenges that are presented by the routing protocols in mobile ad hoc networks. 4. To evaluate the routing protocols in terms of their effectiveness in the context of wireless mobile networks and wireless static networks. For the purpose of assessing the performance of this network scenario, both mobile and static nodes are used. 5. A study of the performance is carried out for each of the routing protocols using the data that was previously gathered on the performance indicators. 6. The overall performance of a number of different routing methods is evaluated and compared. Determine the cause of the energy loss and the following collisions that occur in the network, and then make the required adjustments to limit the number of collisions via collaborative communication.

2. Related Work

V.K.Taksande and Dr. K.D. Kulat [18] has carried out an in-depth investigation of the many different routing protocols used in ad hoc networks. The purpose of this research is to evaluate the performance of several IEEE 802.11 MAC protocols in ad hoc networks. These protocols include DSR, AODV, DSDV, and others. For the purpose of data simulation, a Network Simulator-2, often known as NS2, was used. Several performance characteristics of mobile ad hoc networks, such as sent packet, received packet, Packet delivery ratio, lost packets, etc., with regard to a particular number of nodes are the subject of an in-depth analysis. The most efficient method may be selected from the ones listed above by simulating the experiment in order to analyze how these factors affect the results.

A standard approach for estimating the stochastic characteristics of protocols used in mobile ad hoc networks was described by FatemehGhassemi, Ali Movaghar, and Wan Fokkink [19]. The purpose of this theory, which was presented by Fatemeh Ghassemiet Al, is to comprehend the link that exists between the stochastic performance of protocols that are used throughout a variety of different network levels (there are a total of 19). The authors have estimated the uplink and downlink lifespans by employing node mobility and the link connection model. To hypo-proposed work the mobile ad hoc networks, a constrained labeled multi-transition system, also known as CLMS, is used. In this system, transitions are interpreted based on the limits of the network.

Around the turn of the century, Samir R. Das, Castaneda, and Jiangtao Yan [20] put forth a proposal for a routing protocol. As a result of this research, quite a few routing protocols were proposed that were appropriate for any form of mobile, wireless, or ad hoc network. The findings were derived from simulations that were carried out at the packet level. It has given a few different sets of protocols, one of which is comprised of routing protocols that have been developed specifically for ad hoc networks. The assessment of performance is based on the delivery of packets, the end-to-end latency, and the data traffic in the network, as well as the behavior of protocols in the mobility model. It has been seen that on-demand routing methods operate pretty effectively with a reduced amount of routing burden.

Samir R. Das, Robert Castaiieda and Jiangtao Yan, and Rimli Sengupta [21] The authors of this study, S. Vinothkumaret al., suggested a unique method that makes use of Joint authentication and topology control, which is more often referred to as JATC. This method was developed as a strategy to improve the quality of the output and to further assist in improving the stochastic features of the network. The JATC approach was used in order to lessen the quantity of data that was lost, which resulted in an increase in the channel bandwidth as well as the performance of the channel. Through more efficient exploitation of the channel, both the bandwidth consumption and the likelihood of overloading may be reduced. Some fundamentally useful functions were introduced, by which the channel bandwidth might be distributed in response to specific requirements. The consumers will be able to choose the needed bandwidth depending on the number of channels they need and the quality of the output using this.

An effective DSDV protocol for ad hoc networks has been presented by Khaleel Ur Rahman, Venugopal A Reddy, Rafi U Zaman, K Aditya Reddy, and T Sri Harsha [22]. This protocol is written as Eff-DSDV. The primary objective of this protocol is to address the problems caused by obsolete routes; by removing these routes, it is anticipated that the performance of conventional DSDV would see a significant improvement. Saleh Ali K, Al-Omari, and Putra Sumari [23] examined the particular features of ad hoc networks and identified the benefits and drawbacks associated with the same. Because of this information, the researchers have been able to arrange, evaluate, and present the applications and services that may be achieved via the use of ad hoc networks.

A new routing protocol has been developed by Azizah Abdul Rahman, Mueen Uddin, Abdul Rahman Alarfi, Muhammed Talha, Albert Zomaya, MohsinIftikar, and Asadullah Shah. This protocol is based on the query localization approach and operates according to its principles. This strategy has the potential to considerably cut down on the amount of traffic that is present inside the network, which will ultimately lead to an improvement in the network's overall performance. In their research [24], Vanita Rani and Dr. Renu Dhir give an overview of the mobile ad hoc network, which includes a variety of node kinds. These nodes are separated into three categories: end-to-end nodes, intermediate nodes, and wireless antenna nodes. Ankur Lal, Dr. Sipi Dubey, and Bharat Peswani [25] evaluate the performance of DSDV, AODV, and DSR protocols by taking into account a number of characteristics. These parameters include results, throughput, and routing load.

The performance of a variety of ad hoc routing protocols, including AOMDV, AODV, DSDV, TORA, and DSR, has been evaluated by Jaya Jacoba and V.Seethalakshmi [26]. The performance of these methods was evaluated based on how well they conserved energy during the course of the experiment. Additionally, they presented a new routing algorithm that may induce specific modifications to AOMDV in order to make it more resilient and squeeze every potential efficiency out of it, which would allow it to perform better in comparison to competing protocols.

The study by FJithong Wang, Yuhiro Yonamine, Takashi Iokawa, Eiichiro Kodama, and Toyoo Takata [27] provides a framework model with two different techniques to achieve it. The first one is the one that is put to use to build a house-watching network and is the one that is responsible for awakening the terminals that are snoozing. This will guarantee that intermittent or planned communication may be maintained even if customers are free to enter sleep mode at any point in time that is deemed to be most convenient. This will be the case even if the timing is discovered to be optimum. The second approach is used to include the sleeping terminal in addition to the routing protocols. This makes it possible for the customer's consideration for the welfare of other people to be technically sustained. In addition, they are able to receive information about their terminals, which allows them to determine whether the terminals are functioning as switches. If it is discovered that the terminals are in the sleep state, then they may be relocated safely without interfering with the transmission and relaying that is now taking place, as well as without interfering with the communication of others. Experiments and simulations of different kinds have shown that these methods are effective in their intended applications.

Ekta Barkhodia, Parulpreet Singh, and Gurleen Kaur Walia [28] that demonstrates the impact of a black hole assault on an ad hoc network by using the AODV 22 protocol in combination with HTTP traffic load suggested a study. This paper was presented at a conference. In a case study comparing AODV [2] and PBRS, Saroj Kr. Lanka, Sourabh Singh Verma, and R.B. Patel [29] found that PBRS offers more advantages than AODV [2] in terms of priority and preemption. This was shown by the fact that PBRS was shown to be more advantageous.

Ammar Odeh, Eman Abdul Fattah, and Muneer Alshowkon [30] have assessed the performance of the DSR and AODV protocols while taking into consideration the size of the packets. A plan that included protocol Preemption and Bandwidth Reservation was proposed by Sourabh Singh Verma, Saro Kr. Lankaa, and R.B. Patel [31]. This plan was given the acronym PBRS. Combining AQR and AODV into one strategy provides more capabilities for this system. In addition to preserving bandwidth, the authors have developed a preemption scheme. Within this preemption scheme, the number of preemptions is decreased, which helps to guarantee that preemptions are carried out fairly.

3. Proposed Methodology

Some people regard ad hoc on-demand distance vector, often known as AODV for short, to be a hybrid of dynamic source routing (DSR) and destination sequenced distance vector (DSDV). It implements the core on-demand procedures that are characteristic of DSR. Including things like Route Discovery and maintenance, in addition to hop-to-hop routing sequencing derived from DSDV. AODV is an example of an on-demand routing protocol since the route discovery process will not begin unless it is requested by the source node.

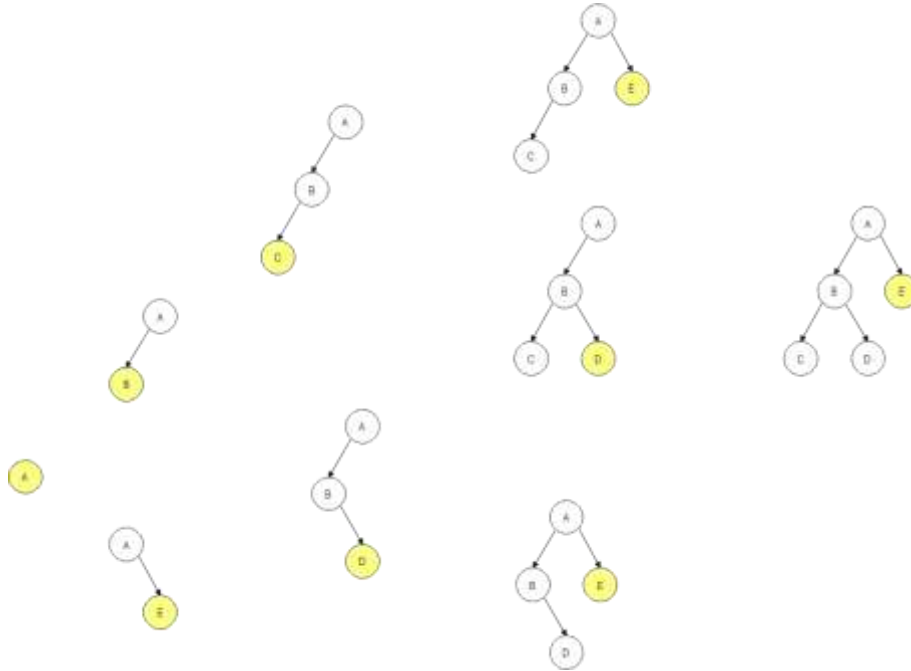

Figure 3: Node Allocation

When a source node, let's call it S_n , wants to trade data with a destination node, let's call it D_n , S_n has to discover D_n first, and then it needs to find a way to get to D_n . It's possible that the S_n 's routing database doesn't have any information about the D_n 's routes sometimes. As a result, it is essential to search for an alternative path. In order to do this, the S_n will broadcast inside the network a route request, also known as RREQ packets. These packets will include the identifying parameter of the destination, which will be denoted by the letter D_n .

When its neighbors get this RREQ, the only time they'll send it to other nodes in their area is if there isn't already a "fresh" route to the destination they're trying to reach. This process will continue until the RREQ packet is sent to the target node or any other node that is aware of a route to the destination from any other node. In AODV, each node will be issued a unique sequence number, RREQ ID. This assists in preventing the connection from being looped and provides a new instance of the route each time it is used. Each RREQ will be assigned a one-of-a-kind new ID that will be greater than its previous ID thanks to the assistance of IP addresses. As a result, a new and updated version of the route will be generated each time an RREQ is sent.

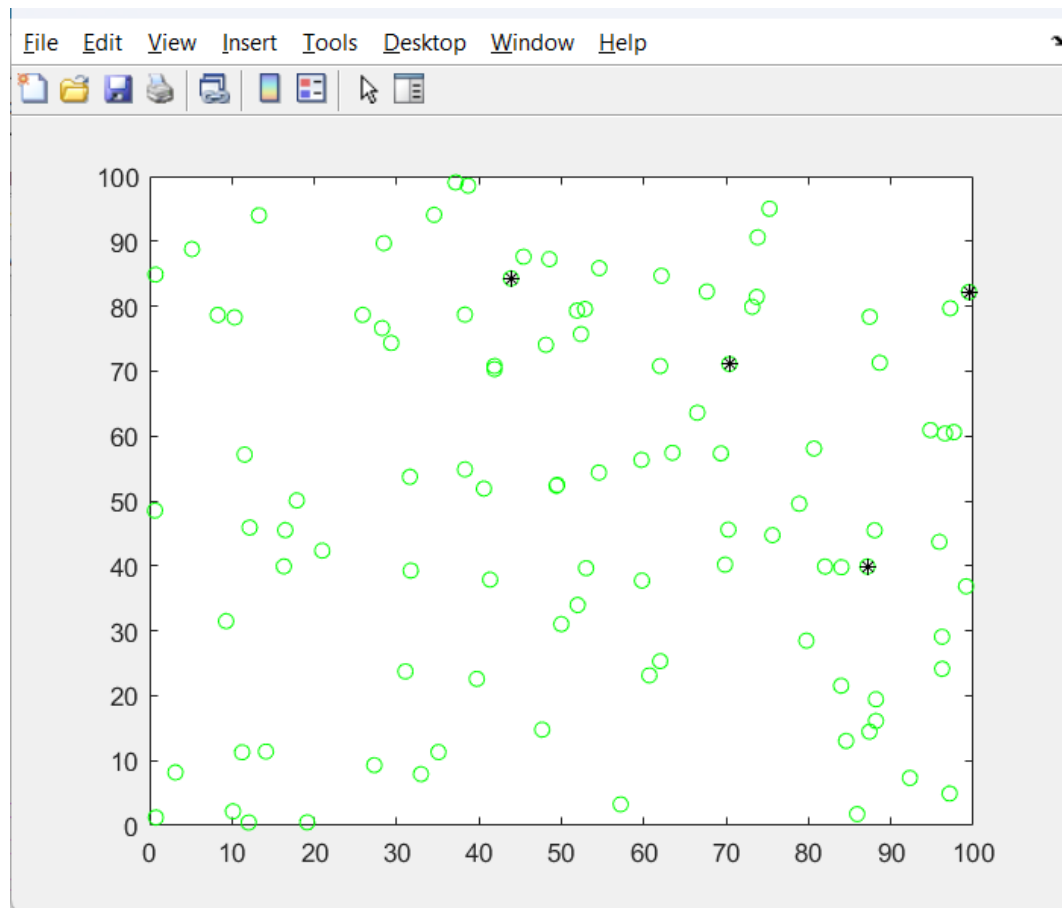

Figure 4: Node Allocation

When a node transmits the RREQ, it will, with the assistance of the nearby nodes from whom it had received the RREQ packet, build a reverse route from itself to the source node S_n . This route will begin at the node that sent the RREQ. This reverse route's objective is to ensure that the subsequent route reply, also known as the RREP packet, is sent to the source node S_n in the event that the RREQ is obtained by the destination node D_n or a path to the destination node is found. If this is the case, the RREP will provide the routing information, including the total number of hops necessary to go to D from S_n . The route sequence number will advance by one each time the RREP is sent out into the network to reach source node S_n . This indicates the total number of hops taken to reach source node S_n . After the S_n has obtained the RREP, an indication that the RREP packet has been obtained will be sent in the form of a route reply acknowledgment, abbreviated as RREP-ACK.

The transmission of text messages at regular intervals helps keep the routes up-to-date and functional. Every node in the AODV is required to comply with a regulation that stipulates the sending of a hello message at a pace of at least one message per second. In the event that a node fails to deliver the welcome message for three iterations in a row, then the neighbors of that node may come to the conclusion that the connection to that node has been severed.

When a situation like this arises, route maintenance is requested by sending route error messages, also known as RERR messages. When a node discovers a broken connection, it will send a RERR packet to the neighboring node that makes use of the broken link in its routing. This packet will be relayed to all of the nodes, which will alert each node to the fact that the connection has been broken. Any node that gets an RREQ, RREP, RREP-ACK, or even RERR packet has the ability to immediately update the sequence numbers in its routing table. This is a standard procedure that applies to all nodes.

Route Table Management

The following parameters of the routing table need to be monitored by AODV in order to ensure that the connections are maintained and kept current. These are the titles that appear at the top of each table.

1. The Internet Protocol (IP) address of the destination.
2. The number in the Destination Sequence
3. The Hop Count provides the total number of hops that are necessary to reach a certain location.
4. The subsequent hop, often known as the nearby node, is responsible for transmitting the data.
5. Lifetime refers to the length of time that the route is valid.
6. Active neighbor list consists of all of the nodes that utilize this route entry.
7. Request buffer: this will guarantee that a request is only ever handled once.

When compared to other conventional routing protocols, the AODV offers various benefits, some of which are as follows:

1. The reactive on-demand strategy that AODV uses helps to reduce the total amount of routing messages that are sent across the network.
2. The AODV routing protocol is highly suited for use in an ad-hoc network, which may achieve excellent performance even in the event that the topology of the network is altered.
3. Because the AODV employs the sequence number to reflect the freshness of the route, there will be a significant decrease in the number of loops that exist inside the network.
4. AODV is readily modifiable in order to give more than one route per destination. This allows for an alternative route to be attempted in the event that the current route becomes invalid.
5. When it comes to data transmission, AODV won't need any assistance from the link layer since it sends the packets at the IP level.

In addition to a number of positive aspects, the AODV also has certain drawbacks;

1. If the network is partitioned, the sequence numbers will not be synced, and the routing will be completely messed up.
2. AODV has the capability of sending the packet at the IP level instead of using the link layer.
3. AODV does not allow unidirectional connections.

3.1 DSDV or Destination Sequenced Distance Vector

The data are sent from hop to hop using the DSDV [43] protocol, which is a distance vector routing mechanism. Every node that participates in DSDV will be responsible for maintaining a routing information table that comprises information on all of the other destinations, the next hop that is required to reach those destinations, as well as the total number of hops. In order to keep the routing tables up to date, the distance-vector shortest path routing protocol (DSDV), like any other distance-vector routing system, requires that the component nodes broadcast hello messages on a regular basis. Despite this, the DSDV is superior to traditional distance vector protocols since it cannot be looped around itself as other protocols do.

The DSDV system employs a sequence of numbers and designates each route in order to prevent routes from being looped. A path's age may be determined by looking at its number sequence; routes with higher numbers are often seen as offering more advantages. For example, if the sequence number of route P1 is higher than that of path P2, then path P1 is considered to be the more advantageous option. In the event that both routes have the same numbers, the one that has a lower hop count will be chosen as the best option.

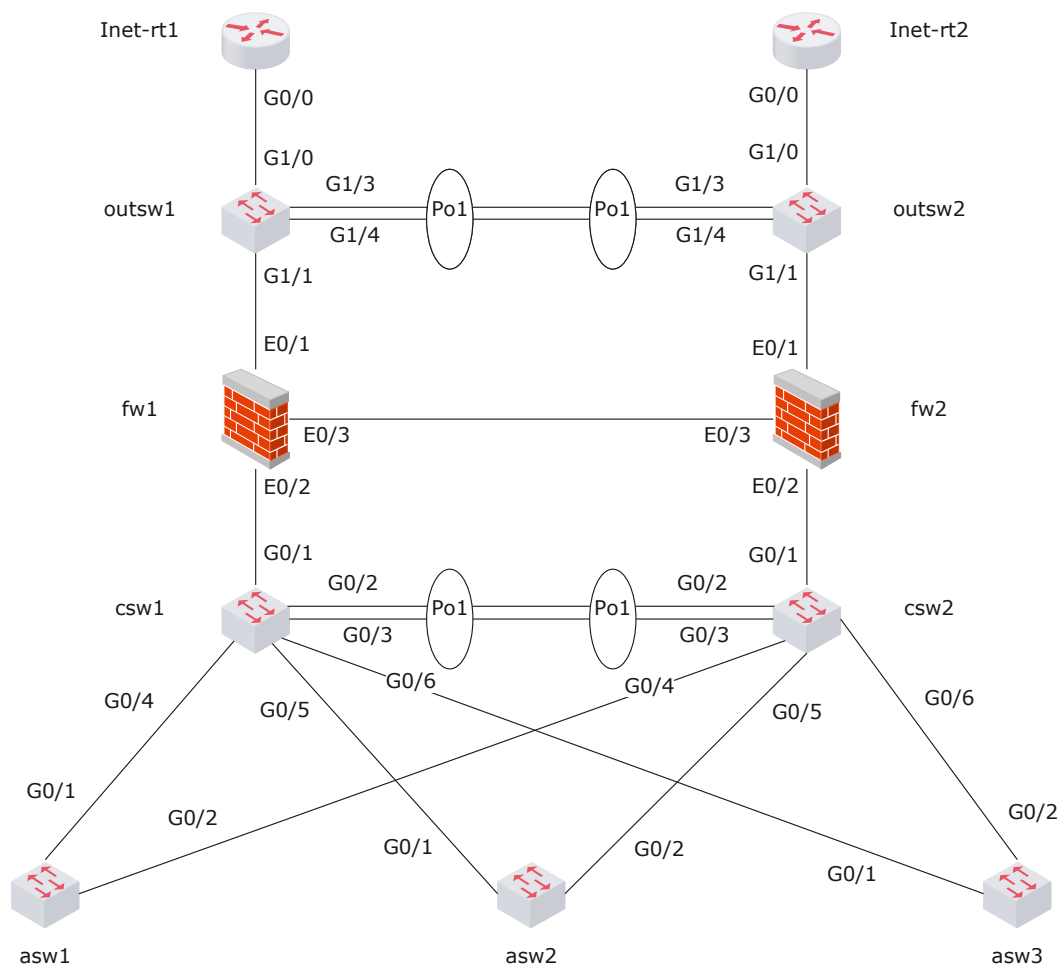

Figure 5: Routing topology

The sequence number will be increased by one each time a node N1 determines that a route leading to a particular destination D1 has been compromised. As a consequence of this, when node N1 broadcasts its routes, it will show that the route to destination D1 has an infinite hop count.

In its most basic form, DSDV is a distance vector protocol that has undergone some minor modifications in order to enhance its performance and make it more appropriate for use in wireless ad hoc networks. These alterations include induced updates sent by regular broadcasts, which will address changes in topology as they occur. There are two distinct kinds of updating messages that may be used to cut down on the number of data packets and bandwidth. Both of these types of dumps are referred to as incremental dumps and complete dumps. The difference between an incremental dump and a complete dump is that the full dump comprises all of the information pertaining to routing data, whereas an incremental dump just contains the information that has changed since the last dump. Table-driven routing is a method that is used by the DSDV protocol, which stands for the Destination-Sequenced Distance Vector protocol. This protocol is an improved version of the classic Bellman-Ford routing system. The Routing Information Protocol (RIP) served as a conceptual jumping-off point for the development of DSDV. In order for a RIP method to function properly, each node in the network must have a routing table that details the destinations in the network as well

as the required number of hops to reach each of those destinations. Due to the fact that DSDV supports some components of distance vector routing, it is capable of implementing bidirectional linkages. On the other hand, there is only one path that can be taken to go from the origin to the destination using this method.

This method eliminates the possibility of network loops thanks to an additional safeguard provided by DSDV, which requires that each node transmit a broadcast message in order to often update the routing table. The configuration of the routing table is not too complicated to understand. Every single item that is included in the table has a one-of-a-kind sequence number, the value of which is increased each time the node broadcasts an updated message. The update message is sent out across the network every time there is a change in the topology of the network. This is done in order to ensure that the information about the network is always accurate.

When a node sends routing information repeatedly over the course of some period of time, it will embed the packets with the information of its new sequence number as well as the sequence number of the destination, in addition to the destination's address and the total number of hops that are required to reach the destination. When a node in the network detects a shift in the topology of the network, it will distribute an update packet to the other nodes in its immediate vicinity. Because the DSDV is dependent on frequent updates of routing information, the initialization of the route takes some time before it can be used. This is because of the DSDV. This results in a slightly longer period of time which is referred to as the converging time. The effect of converge time is insignificant in a wired network because the topology of the network does not change in a random fashion. A wired network is by its very definition a static network. However, in the case of a mobile ad-hoc network, the topology of the network is subject to change at any time and without any prior notification. As a consequence of this, the converging time may end up causing an unpleasant loss of packets because the routes will not have been initialized at that point. In addition to this, the frequent transmission of broadcast messages is adding to the congestion in the network.

3.3 DSR or Dynamic Source Routing

The DSR methods do not use hop-to-hop routing; rather, they use source routing algorithms. A header will be attached to the data packet, and it will include all of the information about the nodes that are responsible for delivering the packet to its final destination. Because the packets already contain all of the necessary routing information, such as hops and transmitting nodes, the intermediate nodes are not required to maintain a routing table, nor are they required to update it. This is because the packets already contain all of the necessary routing information. This is an additional advantage that comes with using this approach. This system, which is a combination of source routing and routing on demand, eliminates the need for regular route discovery and advertising as well as the need to update routing information.

During the process of route discovery, node S must acquire a source route to destination D since it is assumed that node S will deliver some data to destination D. A straightforward request-and-reply methodology is used in the process of route discovery. To get things started, the source node S will send out a route request, also known as an RREQ packet, to all of the nodes in the network that are within its sphere of influence. This message will be flooded over the network, and there will be no congestion as a result. When this request reaches the destination or a node that is aware of the path to the destination, a reply is sent in the form of a route reply, which is abbreviated as RREP. This reply includes the routing information necessary to reach the destination. A node will save a cached copy of this information if it learns or overhears information about a particular source-to-destination path. Because it will then be possible to reuse it, which will lower the cost of route finding and will also reduce the amount of RREQ flooding that occurs in the network.

When there has been a change in the topology of the network, route maintenance becomes necessary. Take into consideration a situation in which data are being sent from a source node S to a destination node D along a specified route. It is also conceivable that the connection or route will be severed if one or more of the nodes along that way move out of range. In this scenario, the connection or path will be severed. In certain circumstances, the source will be unable to transmit data to the destination over that path. When anything like this occurs, the route maintenance will alert the source node that the source route is no longer accessible by sending an error message to the router. The packet will state that the source route is no longer available. When this occurs, the source node must either use

the previously cached routing information to determine an alternative path to the destination, or it must make the route request anew from the beginning.

DSR, which stands for "Dynamic Source Routing," is a component of reactive protocols that gives the constituent nodes the ability to dynamically select the path to any destination, which may include a number of hops around the network. When using the source routing strategy, the routing information is included in the header of each transmitting packet. This header comprises a categorized list of the nodes that are encountered along the path of the packet. The DSR protocol does not employ route advertising or regular route update, which results in a significant reduction in both the bandwidth overhead and the power consumption of the system. The total battery backup in the ad-hoc network may be significantly increased with the help of this technology. The DSR may also make use of the MAC layer, which is responsible for keeping the routing protocol updated with information on any broken links that may have occurred.

When a packet travels from node A to node C through node B, then node A is able to get knowledge on the routing to both node A and node B. On the other hand, information on routing that is relevant to nodes A and C will likewise be learned by node B. Node C also has this capability, which enables it to get knowledge of routing information relevant to nodes A and B.

1. DSR enables connections and transmissions across unidirectional lines with the assistance of the MAC protocol, which has the potential to improve the functionality of the network.

In addition to its many benefits, DSR does come with a few drawbacks. Because the packets need to contain the routing information, the size of the packets increases, which may result in the packets being rather big when there are a significant number of hops between the source and the destination. This will have a devastating impact on the network.

There is the potential for information to be compromised due to the fact that the packets that are sent via DSR protocols may be read by the nodes that forward them. In DSR, the address filtering that is normally performed on the interface will be disabled. This indicates that it is possible for an adversary to obtain access to the packets and then quickly extract the information that is stored inside them. In some circumstances, this information is highly sensitive, and any disclosure of it might result in a significant decrease in the number of customers served. As a result, there is a need for the provision of data encryption, which might result in an increase in the algorithm's level of complexity.

3.4 Zone Routing Protocol – ZRP

The ZRP Zone Routing Protocol is an innovative hybrid that combines reactive and proactive routing protocol strategies. The network is partitioned into a great number of routing zones using this protocol. IARP, which stands for Intra-zone Routing Protocol, is a protocol that operates inside a routing zone. It is responsible for determining the minimum distance between all of the nodes in the zone as well as the pathways that go to them. Because it is not constrained in any way, IARP is free to make use of any number of proactive protocols for either Distance Vector routing or link state routing. This suggests that the methods used in each zone are distinct from one another. However, this does not have an effect on the network provided that the protocols in question are confined to the zones designated for them.

The primary benefit of using an approach of this kind is that any changes made to the topology of the network will not have an effect on the whole of the system; rather, the update message will be concerned only with the routing zone.

The Inter-zone Routing Protocol, often known as IERP, is a protocol that functions in a reactive manner and contributes to the process of selecting routes across different routing zones. As a result, it makes it easier to create connections across different routing zones. When the source wants to transfer data to a destination that is situated in a different routing zone, this protocol comes in quite helpful since it allows for that to happen.

The purpose of this protocol is to send a message that contains a route request, which is abbreviated as RREQ. This message is broadcast to all of the nodes that are located on the boundary of the routing zone. In the event that the destination node is not located inside the routing zone of the border node, the request will be sent to another zone as soon as the border node is in possession of the

RREQ. This strategy is continued right up to the point when the target node is found for good. After then, the node at the destination will send a route reply, also known as an RREP, back to the source. This RREP will provide the path for transmission.

4. Experimental Analysis

The results of qualitative analysis obtained through a variety of experiments are summarised in Table 2, which presents a comparison of various routing protocols. The tabulation reveals, without a shadow of a doubt, the properties that are included in some protocols but omitted from others.

Table 1: Simulation parameters

Simulation Parameters	Range
Number of nodes	100
Speed of node	5,10,15,20 and 25 m/s
Length of packet	512
Number of transmitted packets	899
Considered Model	Random Way
Range of transmission	250 m
Simulation Area	1500x1500 m ²
Simulation time	900sec

It is clear from examining the chart that none of the protocols provide any capabilities for reducing power consumption or improving the quality of service. Despite this, a number of investigations and research are now being conducted in order to include these aspects in the procedures. However, on the bright side, all of the protocols are dynamic in nature, meaning that they are able to reconfigure themselves in response to changes in the topology. As a result, these protocols are autonomous and do not require any kind of centralized node.

The DSDV protocol is the only proactive one examined in this comparative analysis. In addition, DSDV is the only protocol that resembles traditional routing protocols used in wired networks in any way, and it is the only protocol that does so. Sequence numbers are used in DSDV in order to clear the routes of any routes. The performance of DSDV is improved in networks with lower levels of mobility. This may be considered a restriction; as a result of various modifications, AODV was eventually developed. It's possible to think of AODV as a kind of reactive variation of DSDV. Efforts were made to increase the performance by using multicast methods, in which a single node may concurrently broadcast data to numerous other nodes.

Table 2: Comparison between ad-hoc routing protocols.

	AODV	TORA	ZRP	DSDV	DSR	CBRP
Loop-free	Yes	No, short	Yes	Yes	Yes	Yes
Multiple routes	No	Yes	No	No	Yes	Yes
Distributed	Yes	Yes	Yes	Yes	Yes	Yes
Reactive	Yes	Yes	Partially	No	Yes	Yes
Unidirectional link	No	No	No	No	Yes	Yes
QoS Support	No	No	No	No	No	No
Multicast	Yes	No	No	No	No	No
Security	No	No	No	No	No	No
Power conservation	No	No	No	No	No	No
Periodic broadcasts	Yes	Yes	Yes	Yes	No	Yes
Requires reliable or	No	Yes	No	No	No	No

The DSDV protocol is the only proactive one examined in this comparative analysis. In addition, DSDV is the only protocol that resembles traditional routing protocols used in wired networks in any way, and it is the only protocol that does so. Sequence numbers are used in DSDV in order to clear the routes of any routes. The performance of DSDV is improved in a network where there is less mobility. This may be considered a restriction; as a result of various modifications, AODV was eventually developed. It's possible to think of AODV as a kind of reactive variation of DSDV. There were efforts made to increase the performance by introducing multicast methods, which is a method in which a single node may concurrently broadcast data to a number of other nodes.

On the other hand, one might argue that these aspects of AODV are somewhat comparable to the reactive schemes of DSR. This is because both of these protocols employ a route discovery mode that sends request messages to nodes in order to determine new pathways. The only distinction is that DSR will learn more routing information than AODV does based on the source routing methods; nevertheless, this is where the difference stops. DSR, in contrast to AODV, has support for unidirectional connections, which is a significant advantage. The other side of the coin is that the packets in DSR are required to have the source route information with them at all times. This will lead to an increase in the cost of operation and, as a result, a decrease in the quality of service provided by the network.

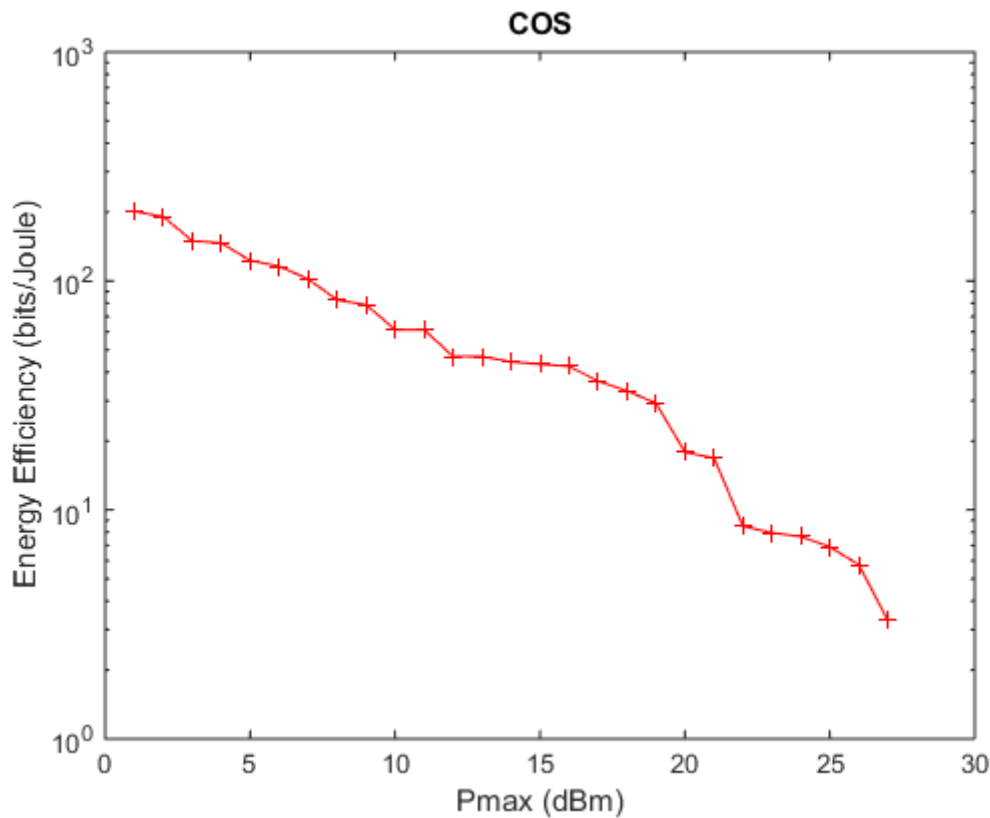

Figure 6: Output of Energy Efficiency

Both the CBRP and the ZRP are really interesting protocols to look at when it comes to partitioning the network into a number of different zones or clusters. This is of great use for big networks that include a significant number of nodes and customers. This method employs proactive protocols for communication inside the zones or clusters, while reactive protocols are used for communication across the various zones or clusters. These reactive systems have an initial step that discovers routes in a manner similar to that of AODV and DSR.

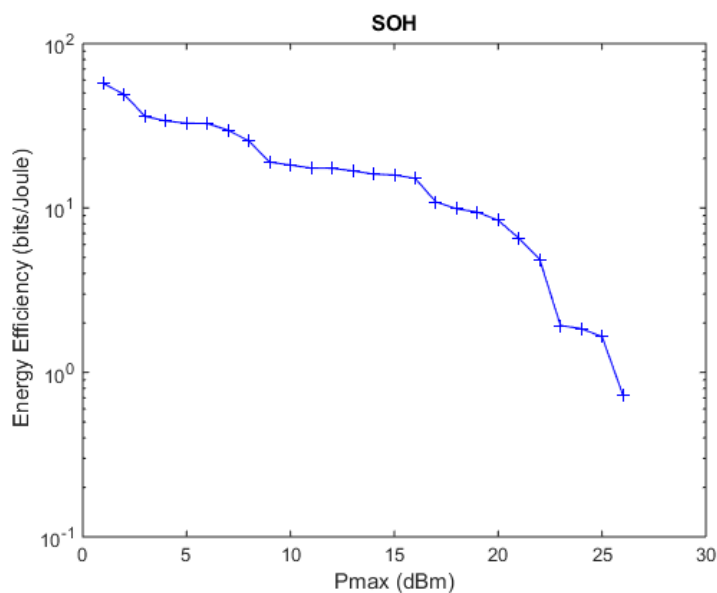

Figure 7: Output of Energy Efficiency 1

There are just a few key distinctions that exist between ZRP and CBRP, and those are contingent on the partition of the network. When using ZRP, the subdivided zones will overlap with each other; however, when using CBRP, the clusters have the option of either overlapping or remaining separate from one another. On the other hand, in contrast to other adaptive protocols, these protocols do not make any essential adjustments to the routing as the traffic load on the network rises.

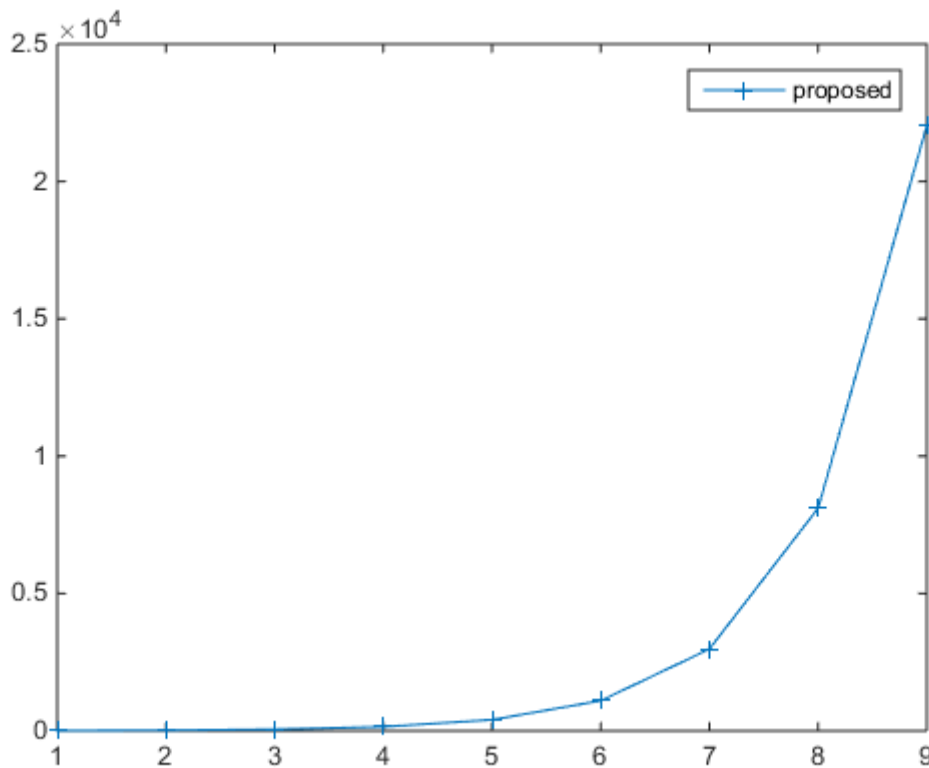

Figure 8: Output of Time Delay

The selection of the best possible route is determined by a variety of criteria, including the shortest road or pathways needing the fewest number of hops, paths offering a speedier response, and so on. However, this may not provide the outcomes that are desired since the packets will be routed in the same way in every case, despite the fact that there are other routes available.

6. Conclusion

Simulations of the MANET using a variety of routing protocols, such as DSDV, DSR, AODV, and TORA, among others, have shown the existence of a need for a specialized ad-hoc routing protocol in situations in which the mobility of the nodes is altered. The performance of more nontraditional protocols, such as DSDV, tends to decline when there is a significant shift in the movement of nodes. On the other hand, AODV and DSR have shown rather satisfactory performance throughout the node mobility. When the size of the network rises, the hop-by-hop routing system, such as AODV, delivers greater performance than other routing protocols.

When it came to managing the load on the network, the DSR performed better than the AODV, the OLSR, and the TORA.

In OLSR, the delay from beginning to finish is less than in AODV, DSR, and TORA, even when there is a lot of traffic. The OLSR demonstrated a performance that was acceptable in both static and mobile ad hoc networks. Additionally, it was unaffected by variations in the size of the network even when the size of the network changed.

The research also suggested a few methods for reducing power consumption in MANET. The most significant of these is the development of effective routing algorithms that may reduce the amount of power that is used by the various network levels. In addition, topology control and power management

strategies are used in order to cut down on the amount of energy consumed. An exhaustive study on the QoS-aware routing protocols used in MANETs is being carried out, and practical solutions to the problem of poor quality of service have been suggested. An examination is carried out on the performance of the routing protocols, which has an effect on the quality of service in terms of the end-to-end latency, the load on the network, and the throughput. The game theory that was constructed was able to give a way by which the features that may be present at different tiers of the protocol stack could be realized. The application of game theory to the modeling of the dynamic features of a MANET, in which the nodes have only partial data, has led to the discovery of hitherto unknown games that include imperfect monitoring. A cursory investigation is performed on the influence that cooperation has on the MANET, and examples are provided to highlight how the impact of adopting cooperation at the physical layer may bring several benefits over the more traditional non-cooperative MANET. Because there is a lesser chance of collision in the network, the use of the available bandwidth is found to be effective, and the level of network overload is found to be low.

Funding: “This research received no external funding”

Conflicts of Interest: “The authors declare no conflict of interest.”

References

- [1] D. B. Johnson and D. A. Maltz, “Dynamic Source Routing in Ad-hoc Wireless Network”, Department of Computer Science Carnegie University, Mellon, 1996.
- [2] Dr. F. Scott, Dr. A. Luiz Dr. J. Ira, and Dr. P. Charles, "Mobile Ad hoc network Routing Protocols Methodologies and Applications", Department of Computer Engineering, Blacksburg Virginia, March 19, 2004.
- [3] “Mobile Ad Hoc Networks”, http://w3.antd.nist.gov/wahn_mahn.shtml. Accessed: April 28, 2010.
- [4] K. Gorantala, “Routing Protocols in Mobile Ad-hoc Networks”, Department of Computer Science, Umeå University, June 15, 2006.
- [5] H. Jeroen, L. Benoit, M. Ingrid, D. Bart, and D. Piet, “Routing in Mobile Ad-hoc Networks”, Department of Information Technology (INTEC), Broadband Communication Networks (IBCN), 2003.
- [6] Dr. G. Aditya and S. Ajaii, “Performance of Mobile Ad-hoc Network using AODV Protocol”, Department of Electronics & Communication Engineering, Department of Information Technology, Maulana Azad National Institute of Technology, Bhopal, India- 462051.
- [7] D.B. Johnson, D.A. Maltz and J. Broch, "The Dynamic Source Routing Protocol for Multi-Hop Wireless Ad Hoc Networks," Department of Computer Science Carnegie Mellon University, 2001.
- [8] L. Kwan Hui, “Performance Enhancement of Temporally-Ordered Routing Algorithm”, School of Computer Science and Software Engineering, The University of Western Australia, 2007. 161
- [9] www.etd.unipi.it/theses/available/etd_5182005122420/unrestricted/LVMM.pdf
- [10] Manel Guerrero Zapata. “SecureAdhoc On-DemandDistanceVectorRouting”. ACM Mobile Computing and Communications Review (MC2R), 6(3):106--107, July 2002.
- [11] C.Siva Ram Murthy and B. S. Manoj. “Ad hoc wireless networks: Architecture and Protocols”. Prentice Hall Publishers, May 2004, ISBN 013147023X.
- [12] K. Dufkova, M. Bjelica, Byongkwon M., L. Kencl, and J.-Y. Le Boudec. “Energy Savings for Cellular Network with Evaluation of Impact on Data TrafficPerformance”, In Proceedings of 2010 European Wireless Conference (EW), pages 916–923, April 2010.
- [13] E. Oh, B. Krishnamachari, X. Liu, and Z. Niu. “Toward Dynamic EnergyEfficient Operation of Cellular Network Infrastructure”, IEEE CommunicationsMagazine, 49(6):56–61, June 2011.
- [14] A. Papadopoulos, A. Navarra, J. A. McCann, and C. M. Pinotti. VIBE: “An Energy Efficient Routing Protocol for Dense and Mobile Sensor Networks”, Journal of Network and Computer Applications, 35(4):1177–1190, July 2012.
- [15] Johnson, D.B., Maltz, D.A. and Broch, J. (2001) DSR: “The Dynamic Source Routing Protocol for Multi-Hop Wireless Ad Hoc Networks”, Ad Hoc Networking, 5, 132-172.
- [16] Yaser Mahmood AHamid and D. K. Lobiyal, “COMPOW Based PCM Protocol for Multi-hop MANET”, submitted to an international journal.

- [17] Chlamtac, I., Conti, M. and Liu, J.N. (2003) "Mobile Ad Hoc Networking: Imperatives and Challenges. Ad Hoc Networks", 1, 13-64. [http://dx.doi.org/10.1016/S1570-8705\(03\)00013-1](http://dx.doi.org/10.1016/S1570-8705(03)00013-1) 162
- [18] V.K.Taksande, Dr.K.D.Kulat, "Performance Comparison of DSDV, DSR, AODV Protocol with IEEE 802.11 MAC for Chain Topology for Mobile Ad-hoc Network using NS-2", 2nd National Conference- Computing, Communication and Sensor Network" CCSN,P.P. 26-31, 2011.
- [19] Fatemeh Ghassemi, Ali Movaghar, Wan Fokkink , "Towards Performance Evaluation of Mobile Ad Hoc Network Protocols".
- [20] S.R. Das, R. Castaneda,Jiangtao Yan , "Comparative Performance Evaluation of Routing Protocols for Mobile, Ad hoc Networks", IEEE, P.P. 153-161, 1998.
- [21] Samir R. Das, Robert Castaiieda and Jiangtao Yan, Rimli Sengupta, "Enhancing Channel Bandwidth with Authentication in MANET Utility Function", International Journal of Advanced Research in Computer Science and Software Engineering, P.P. 1202-1205, 2014.
- [22] Khaleel Ur Rahman Khan, A Venugopal Reddy, Rafi U Zaman, K. Aditya Reddy T Sri Harsha, "An Efficient DSDV Routing Protocol for Wireless Mobile Ad Hoc Networks and its Performance Comparison [11]" , Second UKSIM European Symposium on Computer Modeling and Simulation, IEEE, 506-511, 2008.
- [23] Mueen Uddin, Azizah Abdul Rahman, Abdulrahman Alarifi,Muhammad Talha,Asadullah Shah, Mohsin Iftikhar and Albert Zomaya, "Improving Performance Of Mobile Ad Hoc Networks Using Efficient Tactical On Demand Distance Vector (Taodv) Routing Algorithm", IJICIC, Vol.8, p.p. 4375-4389, June 2012. 163
- [24] Vanita Rani PG Student, Dr. Renu Dhir, "A Study of Ad-Hoc Network: A Review", IJARCSSE, Vol.3, p.p135-138, March, 2013.
- [25] Ankur Lal, Dr.Sipi Dubey, Mr.Bharat Pesswani, "Reliability of MANET through the Performance Evaluation of AODV, DSDV, DSR" IJARCSSE, Vol.2,p.p.213- 216,May,2012
- [26] Jaya Jacob, V.Seethalakshmi , "Performance Analysis and Enhancement of Routing Protocol in Manet", IJMER, Vol.2, p.p.323-328, March,2012.
- [27] Jiahong Wang, Yuhiro Yonamine, Takashi Iokawa, Eiichiro Kodama, and Toyoo Takata, "An Approach to Creating and Maintaining House-Watching Network in MANET",International Multiconference of Engineers and Computer Scientists, Vol.1, 2012.
- [28] Ekta Barkhodia, Parulpreet Singh, Gurleen Kaur Walia "Performance Analysis of AODV using HTTP traffic under Black Hole Attack in MANET",CSEIJ, Vol.2, June 2012.
- [29] Sourabh Singh Verma, Saroj Kr. Lanka, R.B.Patel, "Precedence Based Preemption and Bandwidth Reservation Scheme in MANET", IJCSI, Vol. 9, P.P. 407- 412, 2012.
- [30] Ammar Odeh, Eman AbdelFattah and Muneer Alshowkan, "Performance Evaluation of AODV and DSR Routing Protocols In Manet Networks", International Journal of Distributed and Parallel Systems (IJDPS) Vol.3, P.P. 13-22, 2012. 164
- [31] Sourabh Singh Verma, Saroj Kr. Lanka, R.B.Patel, "Precedence Based Preemption and Bandwidth Reservation Scheme in MANET", International Journal of Computer Science Issues, Vol. 9, P.P.407-412, November 2012.